

## AquaScan Registration Unit CSE3500

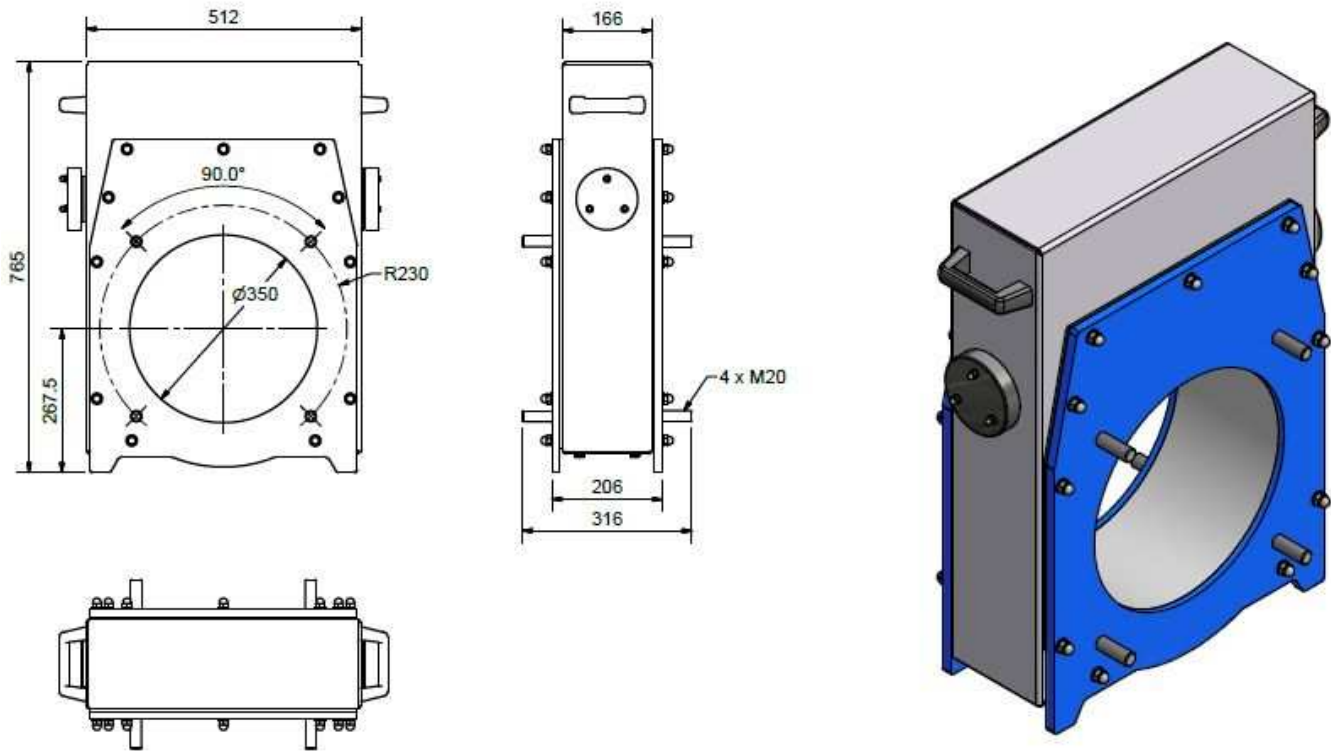

<b>Material</b>	<i>Powder painted aluminium and POM</i>
<b>Weight</b>	<i>32 Kg</i>
<b>Dimensions</b>	<i>765 x 512 x 316mm</i>
<b>Capacity</b>	<i>30 tonnes/unit/hour (1Kg)</i>
<b>Power Consumption</b>	<i>17W</i>
<b>Power supply</b>	<i>Powered by the Control Unit</i>
<b>Flange connection</b>	<i>DN350</i>
<b>Fish size</b>	<i>10g to 18Kg</i>
<b>Accuracy</b>	<i>98-100%</i>
<b>Arrangement</b>	<i>Approx. 30 ° tilt forward. 0 to ¼ pipe transport water</i>
<b>Flow speed</b>	<i>2,5 - 3 m/s</i>
<b>Standard cable length included</b>	<i>10 meters</i>
<b>Requirements</b>	<i>AquaScan Control Unit</i>